

# FAIRFIELD

FAIRFIELD  
DISPLAYS • LIGHTING

## INSTRUCTIONS

### CA4 - CABLES

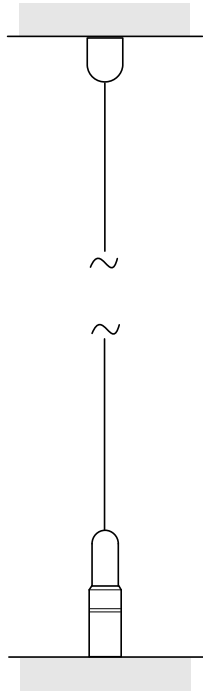

## GUARANTEE

Instr-ca4

Cable / Rod components are manufactured to the highest possible standards of quality.

All our products are covered by a twelve month guarantee against any problems arising through faulty manufacture.

Should any problems be discovered, please contact your sales advisor in the first instance, on the relevant helpline number.

Visit our Website on  
[www.fairfielddisplays.co.uk](http://www.fairfielddisplays.co.uk)

Your local Helpline

Head Office. ....01252 812211

North West Office.....01743 462472

## CEILING FIXINGS

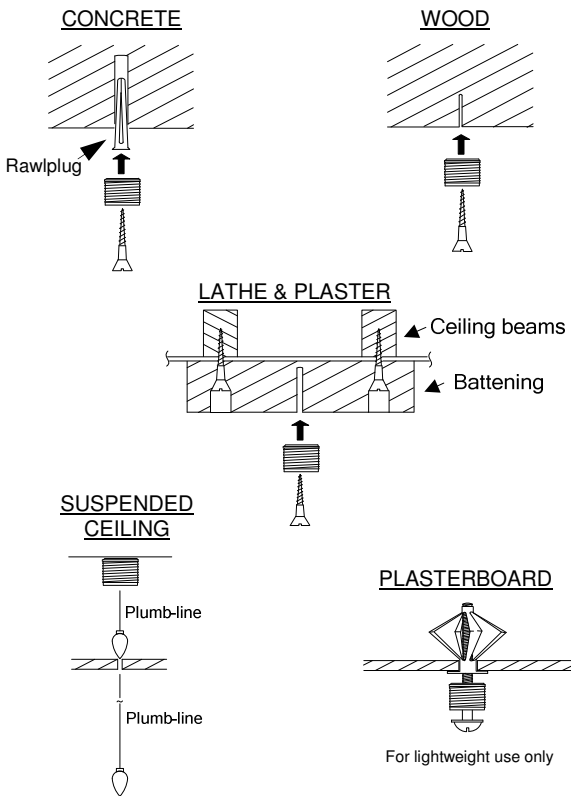

## POCKET FIXING

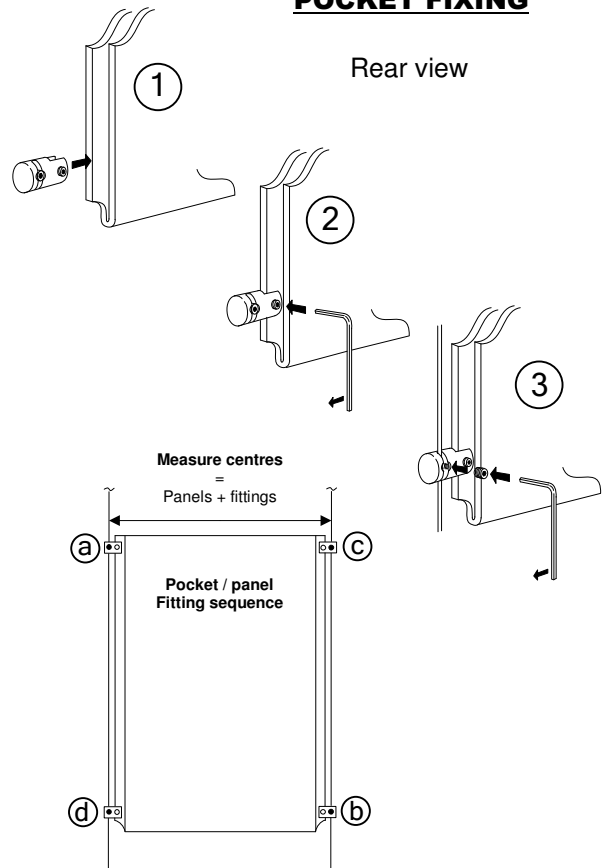

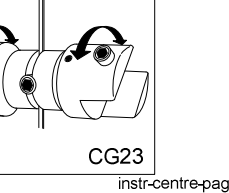
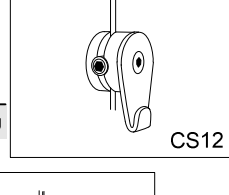
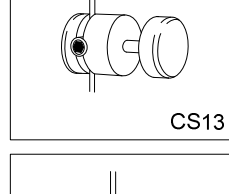
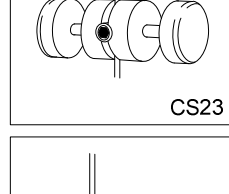
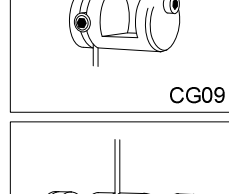
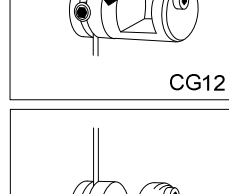
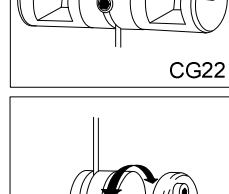
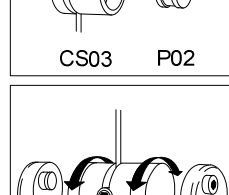
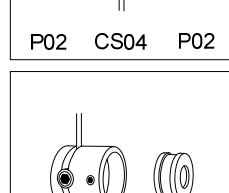
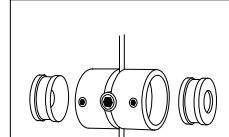
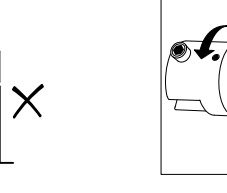
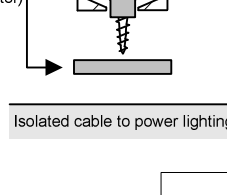
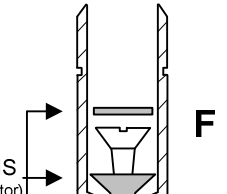
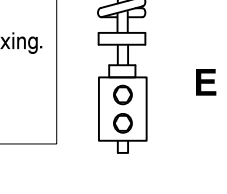
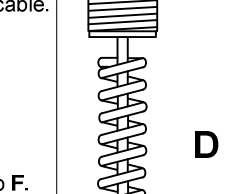
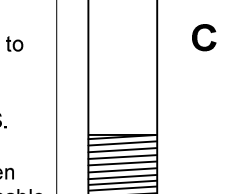
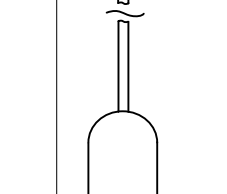
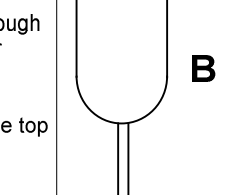
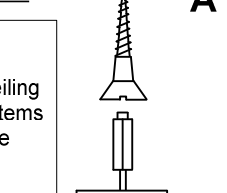
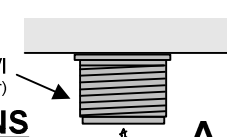
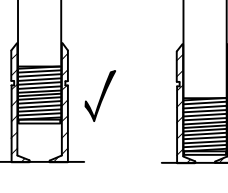
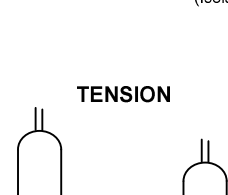
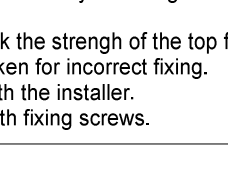
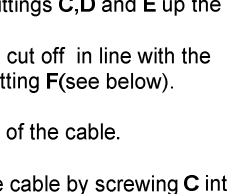
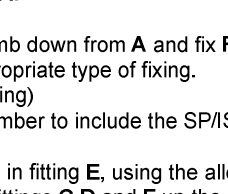
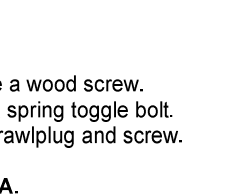
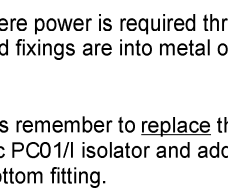
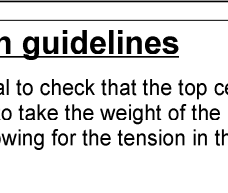
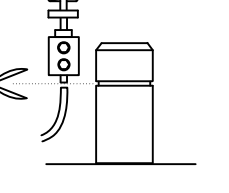
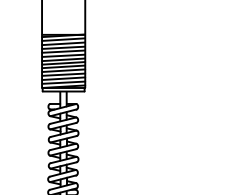
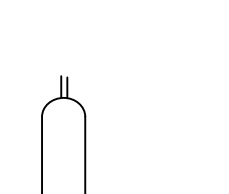
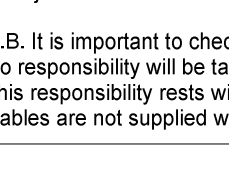
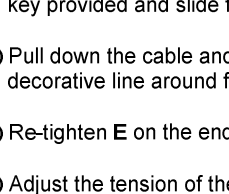
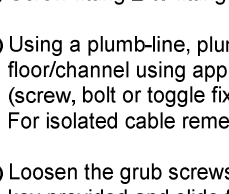
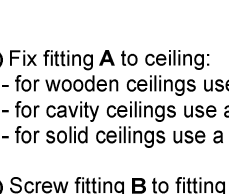
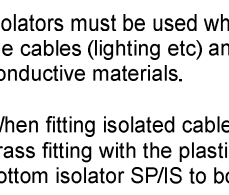
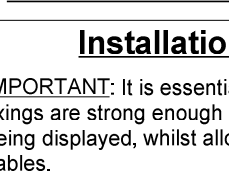
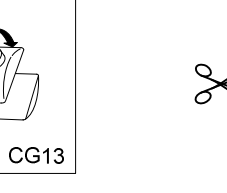
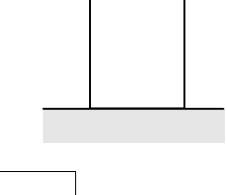
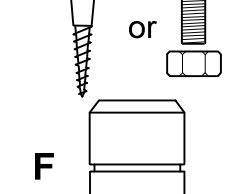
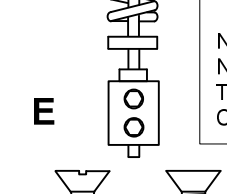
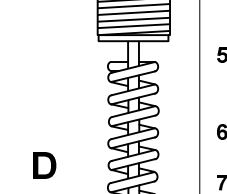
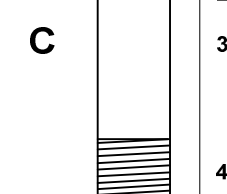
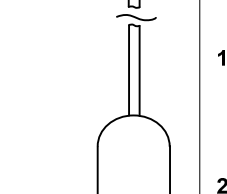
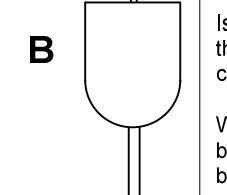
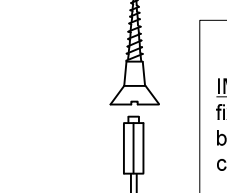
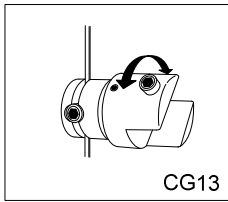
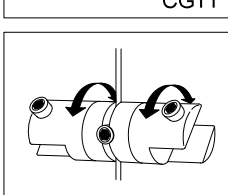
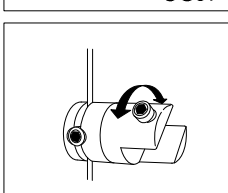
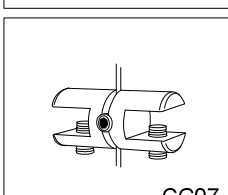
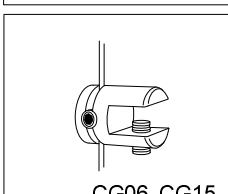
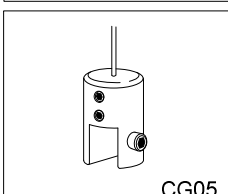
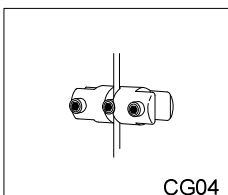
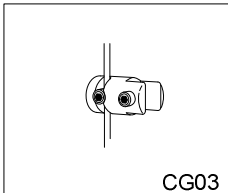
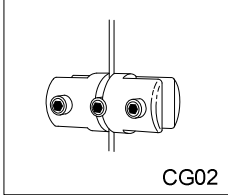
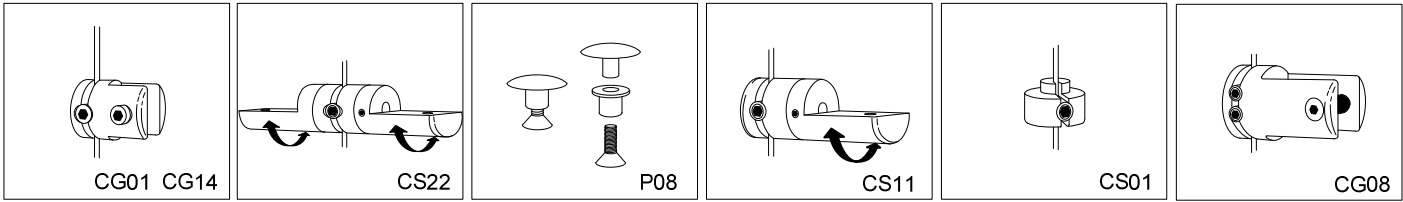

## CABLE FITTING INSTRUCTIONS

### Installation guidelines

**IMPORTANT:** It is essential to check that the top ceiling fixings are strong enough to take the weight of the items being displayed, whilst allowing for the tension in the cables.

Isolators must be used where power is required through the cables (lighting etc) and fixings are into metal or conductive materials.

When fitting isolated cables remember to **replace** the top brass fitting with the plastic PC01/I isolator and add bottom isolator SP/IS to bottom fitting.

- 1) Fix fitting **A** to ceiling:
  - for wooden ceilings use a wood screw.
  - for cavity ceilings use a spring toggle bolt.
  - for solid ceilings use a rawlplug and screw.
- 2) Screw fitting **B** to fitting **A**.
- 3) Using a plumb-line, plumb down from **A** and fix **F** to floor/channel using appropriate type of fixing. (screw, bolt or toggle fixing)  
For isolated cable remember to include the SP/IS.
- 4) Loosen the grub screws in fitting **E**, using the allen key provided and slide fittings **C, D** and **E** up the cable.
- 5) Pull down the cable and cut off in line with the decorative line around fitting **F** (see below).
- 6) Re-tighten **E** on the end of the cable.
- 7) Adjust the tension of the cable by screwing **C** into **F**.

N.B. It is important to check the strength of the top fixing. No responsibility will be taken for incorrect fixing. This responsibility rests with the installer. Cables are not supplied with fixing screws.

PC01/I  
(Isolator)

SP/IS  
(Isolator)

Isolated cable to power lighting

TENSION

